

# NGD18N40ACLB

## Ignition IGBT, 18 A, 400 V N-Channel DPAK

This Logic Level Insulated Gate Bipolar Transistor (IGBT) features monolithic circuitry integrating ESD and Over-Voltage clamped protection for use in inductive coil drivers applications. Primary uses include Ignition, Direct Fuel Injection, or wherever high voltage and high current switching is required.

### Features

- Ideal for Coil-on-Plug Applications
- DPAK Package Offers Smaller Footprint for Increased Board Space
- Gate-Emitter ESD Protection
- Temperature Compensated Gate-Collector Voltage Clamp Limits Stress Applied to Load
- Integrated ESD Diode Protection
- New Design Increases Unclamped Inductive Switching (UIS) Energy Per Area
- Low Threshold Voltage Interfaces Power Loads to Logic or Microprocessor Devices
- Low Saturation Voltage
- High Pulsed Current Capability
- Optional Gate Resistor ( $R_G$ ) and Gate-Emitter Resistor ( $R_{GE}$ )
- Emitter Ballasting for Short-Circuit Capability
- These are Pb-Free Devices

### MAXIMUM RATINGS ( $T_J = 25^\circ\text{C}$ unless otherwise noted)

Rating	Symbol	Value	Unit
Collector-Emitter Voltage	$V_{CES}$	430	$V_{DC}$
Collector-Gate Voltage	$V_{CER}$	430	$V_{DC}$
Gate-Emitter Voltage	$V_{GE}$	18	$V_{DC}$
Collector Current-Continuous @ $T_C = 25^\circ\text{C}$ - Pulsed	$I_C$	15 50	$A_{DC}$ $A_{AC}$
ESD (Human Body Model) $R = 1500 \Omega$ , $C = 100 \text{ pF}$	ESD	8.0	kV
ESD (Machine Model) $R = 0 \Omega$ , $C = 200 \text{ pF}$	ESD	800	V
Total Power Dissipation @ $T_C = 25^\circ\text{C}$ Derate above $25^\circ\text{C}$	$P_D$	115 0.77	Watts $\text{W}/^\circ\text{C}$
Operating and Storage Temperature Range	$T_J, T_{stg}$	-55 to +175	$^\circ\text{C}$

Stresses exceeding those listed in the Maximum Ratings table may damage the device. If any of these limits are exceeded, device functionality should not be assumed, damage may occur and reliability may be affected.



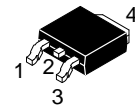
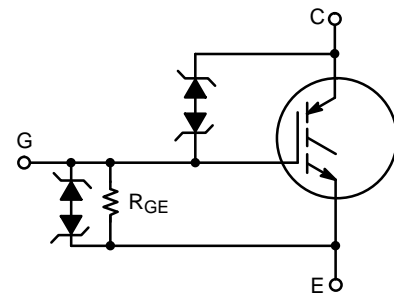
Expertise Applied | Answers Delivered

Littelfuse.com

**18 AMPS, 400 VOLTS**

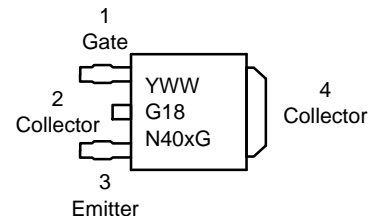
$V_{CE(on)} \leq 2.0 \text{ V @}$

$I_C = 10 \text{ A}, V_{GE} \geq 4.5 \text{ V}$



**DPAK  
CASE 369C  
STYLE 7**

### MARKING DIAGRAM



G18N40x = Device Code  
x = A

Y = Year

WW = Work Week

G = Pb-Free Device

### ORDERING INFORMATION

Device	Package	Shipping
NGD18N40ACLB4G	DPAK (Pb-Free)	2500/Tape & Reel

# NGD18N40ACLB

## UNCLAMPED COLLECTOR-TO-EMITTER AVALANCHE CHARACTERISTICS ( $-55^{\circ}\text{C} \leq T_J \leq 175^{\circ}\text{C}$ )

Characteristic	Symbol	Value	Unit
Single Pulse Collector-to-Emitter Avalanche Energy $V_{CC} = 50\text{ V}$ , $V_{GE} = 5.0\text{ V}$ , Pk $I_L = 21.1\text{ A}$ , $L = 1.8\text{ mH}$ , Starting $T_J = 25^{\circ}\text{C}$ $V_{CC} = 50\text{ V}$ , $V_{GE} = 5.0\text{ V}$ , Pk $I_L = 16.2\text{ A}$ , $L = 3.0\text{ mH}$ , Starting $T_J = 25^{\circ}\text{C}$ $V_{CC} = 50\text{ V}$ , $V_{GE} = 5.0\text{ V}$ , Pk $I_L = 18.3\text{ A}$ , $L = 1.8\text{ mH}$ , Starting $T_J = 125^{\circ}\text{C}$	$E_{AS}$	400 400 300	mJ
Reverse Avalanche Energy $V_{CC} = 100\text{ V}$ , $V_{GE} = 20\text{ V}$ , Pk $I_L = 25.8\text{ A}$ , $L = 6.0\text{ mH}$ , Starting $T_J = 25^{\circ}\text{C}$	$E_{AS(R)}$	2000	mJ

## MAXIMUM SHORT-CIRCUIT TIMES ( $-55^{\circ}\text{C} \leq T_J \leq 150^{\circ}\text{C}$ )

Short Circuit Withstand Time 1 (See Figure 17, 3 Pulses with 10 ms Period)	$t_{sc1}$	750	$\mu\text{s}$
Short Circuit Withstand Time 2 (See Figure 18, 3 Pulses with 10 ms Period)	$t_{sc2}$	5.0	ms

## THERMAL CHARACTERISTICS

Thermal Resistance, Junction to Case	$R_{\theta JC}$	1.3	$^{\circ}\text{C/W}$
Thermal Resistance, Junction to Ambient	$R_{\theta JA}$	95	$^{\circ}\text{C/W}$
Maximum Lead Temperature for Soldering Purposes, 1/8" from case for 5 seconds	$T_L$	275	$^{\circ}\text{C}$

## ELECTRICAL CHARACTERISTICS

Characteristic	Symbol	Test Conditions	Temperature	Min	Typ	Max	Unit
----------------	--------	-----------------	-------------	-----	-----	-----	------

### OFF CHARACTERISTICS

Collector-Emitter Clamp Voltage	$BV_{CES}$	$I_C = 2.0\text{ mA}$	$T_J = -40^{\circ}\text{C}$ to $150^{\circ}\text{C}$	380	395	420	$V_{DC}$
		$I_C = 10\text{ mA}$	$T_J = -40^{\circ}\text{C}$ to $150^{\circ}\text{C}$	390	405	430	
Zero Gate Voltage Collector Current	$I_{CES}$	$V_{CE} = 350\text{ V}$ , $V_{GE} = 0\text{ V}$	$T_J = 25^{\circ}\text{C}$	-	2.0	20	$\mu\text{A}_{DC}$
			$T_J = 150^{\circ}\text{C}$	-	10	40*	
			$T_J = -40^{\circ}\text{C}$	-	1.0	10	
Reverse Collector-Emitter Leakage Current	$I_{ECS}$	$V_{CE} = -24\text{ V}$	$T_J = 25^{\circ}\text{C}$	-	0.7	1.0	mA
			$T_J = 150^{\circ}\text{C}$	-	12	25*	
			$T_J = -40^{\circ}\text{C}$	-	0.1	1.0	
Reverse Collector-Emitter Clamp Voltage	$BV_{CES(R)}$	$I_C = -75\text{ mA}$	$T_J = 25^{\circ}\text{C}$	27	33	37	$V_{DC}$
			$T_J = 150^{\circ}\text{C}$	30	36	40	
			$T_J = -40^{\circ}\text{C}$	25	32	35	
Gate-Emitter Clamp Voltage	$BV_{GES}$	$I_G = 5.0\text{ mA}$	$T_J = -40^{\circ}\text{C}$ to $150^{\circ}\text{C}$	11	13	15	$V_{DC}$
Gate-Emitter Leakage Current	$I_{GES}$	$V_{GE} = 10\text{ V}$	$T_J = -40^{\circ}\text{C}$ to $150^{\circ}\text{C}$	384	640	700	$\mu\text{A}_{DC}$
Gate Emitter Resistor	$R_{GE}$	-	$T_J = -40^{\circ}\text{C}$ to $150^{\circ}\text{C}$	10	16	26	$\text{k}\Omega$

Product parametric performance is indicated in the Electrical Characteristics for the listed test conditions, unless otherwise noted. Product performance may not be indicated by the Electrical Characteristics if operated under different conditions.

1. When surface mounted to an FR4 board using the minimum recommended pad size.

\*Maximum Value of Characteristic across Temperature Range.

# NGD18N40ACLB

## ELECTRICAL CHARACTERISTICS (continued)

Characteristic	Symbol	Test Conditions	Temperature	Min	Typ	Max	Unit
<b>ON CHARACTERISTICS (Note 2)</b>							
Gate Threshold Voltage	$V_{GE(th)}$	$I_C = 1.0 \text{ mA}$ , $V_{GE} = V_{CE}$	$T_J = 25^\circ\text{C}$	1.1	1.4	1.9	$V_{DC}$
			$T_J = 150^\circ\text{C}$	0.75	1.0	1.4	
			$T_J = -40^\circ\text{C}$	1.2	1.6	2.1*	
Threshold Temperature Coefficient (Negative)	-	-	-	-	3.4	-	mV/°C
Collector-to-Emitter On-Voltage	$V_{CE(on)}$	$I_C = 6.0 \text{ A}$ , $V_{GE} = 4.0 \text{ V}$	$T_J = 25^\circ\text{C}$	1.0	1.4	1.6	$V_{DC}$
			$T_J = 150^\circ\text{C}$	0.9	1.3	1.6	
			$T_J = -40^\circ\text{C}$	1.1	1.45	1.7*	
		$I_C = 8.0 \text{ A}$ , $V_{GE} = 4.0 \text{ V}$	$T_J = 25^\circ\text{C}$	1.3	1.6	1.9*	
			$T_J = 150^\circ\text{C}$	1.2	1.55	1.8	
			$T_J = -40^\circ\text{C}$	1.4	1.6	1.9*	
		$I_C = 10 \text{ A}$ , $V_{GE} = 4.0 \text{ V}$	$T_J = 25^\circ\text{C}$	1.4	1.8	2.05	
			$T_J = 150^\circ\text{C}$	1.4	1.8	2.0	
			$T_J = -40^\circ\text{C}$	1.4	1.8	2.1*	
		$I_C = 15 \text{ A}$ , $V_{GE} = 4.0 \text{ V}$	$T_J = 25^\circ\text{C}$	1.8	2.2	2.5	
			$T_J = 150^\circ\text{C}$	2.0	2.4	2.6*	
			$T_J = -40^\circ\text{C}$	1.7	2.1	2.5	
		$I_C = 10 \text{ A}$ , $V_{GE} = 4.5 \text{ V}$	$T_J = 25^\circ\text{C}$	1.3	1.8	2.0*	
			$T_J = 150^\circ\text{C}$	1.3	1.75	2.0*	
			$T_J = -40^\circ\text{C}$	1.4	1.8	2.0*	
$I_C = 6.5 \text{ A}$ , $V_{GE} = 3.7 \text{ V}$	$T_J = 25^\circ\text{C}$	-	-	1.65			
Forward Transconductance	gfs	$V_{CE} = 5.0 \text{ V}$ , $I_C = 6.0 \text{ A}$	$T_J = -40^\circ\text{C}$ to $150^\circ\text{C}$	8.0	14	25	Mhos

## DYNAMIC CHARACTERISTICS

Input Capacitance	$C_{ISS}$	$V_{CC} = 25 \text{ V}$ , $V_{GE} = 0 \text{ V}$ $f = 1.0 \text{ MHz}$	$T_J = -40^\circ\text{C}$ to $150^\circ\text{C}$	400	800	1000	pF
Output Capacitance	$C_{OSS}$			50	75	100	
Transfer Capacitance	$C_{RSS}$			4.0	7.0	10	

## SWITCHING CHARACTERISTICS

Turn-Off Delay Time (Resistive)	$t_{d(off)}$	$V_{CC} = 300 \text{ V}$ , $I_C = 6.5 \text{ A}$ $R_G = 1.0 \text{ k}\Omega$ , $R_L = 46 \Omega$ ,	$T_J = 25^\circ\text{C}$	-	4.0	10	$\mu\text{Sec}$
Fall Time (Resistive)	$t_f$	$V_{CC} = 300 \text{ V}$ , $I_C = 6.5 \text{ A}$ $R_G = 1.0 \text{ k}\Omega$ , $R_L = 46 \Omega$ ,	$T_J = 25^\circ\text{C}$	-	9.0	15	
Turn-On Delay Time	$t_{d(on)}$	$V_{CC} = 10 \text{ V}$ , $I_C = 6.5 \text{ A}$ $R_G = 1.0 \text{ k}\Omega$ , $R_L = 1.5 \Omega$	$T_J = 25^\circ\text{C}$	-	0.7	4.0	$\mu\text{Sec}$
Rise Time	$t_r$	$V_{CC} = 10 \text{ V}$ , $I_C = 6.5 \text{ A}$ $R_G = 1.0 \text{ k}\Omega$ , $R_L = 1.5 \Omega$	$T_J = 25^\circ\text{C}$	-	4.5	7.0	

2. Pulse Test: Pulse Width  $\leq 300 \mu\text{s}$ , Duty Cycle  $\leq 2\%$ .

\*Maximum Value of Characteristic across Temperature Range.

# NGD18N40ACLB

## TYPICAL ELECTRICAL CHARACTERISTICS (unless otherwise noted)

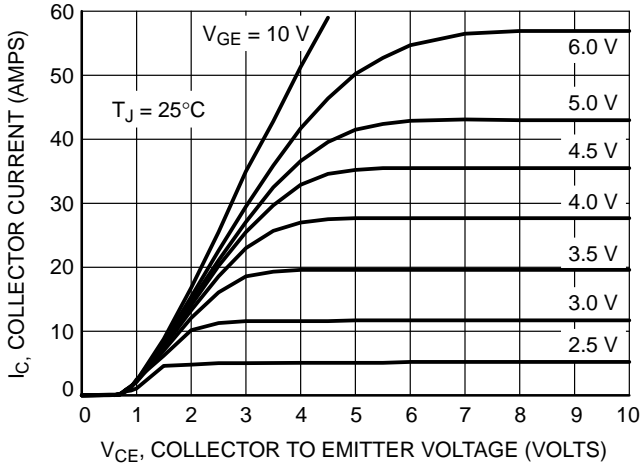


Figure 1. Output Characteristics

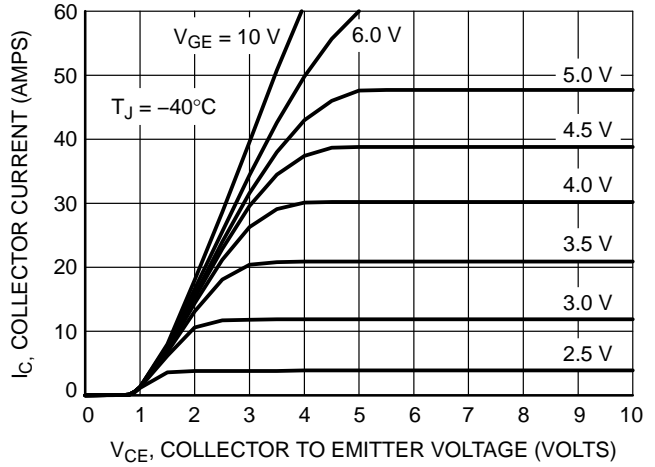


Figure 2. Output Characteristics

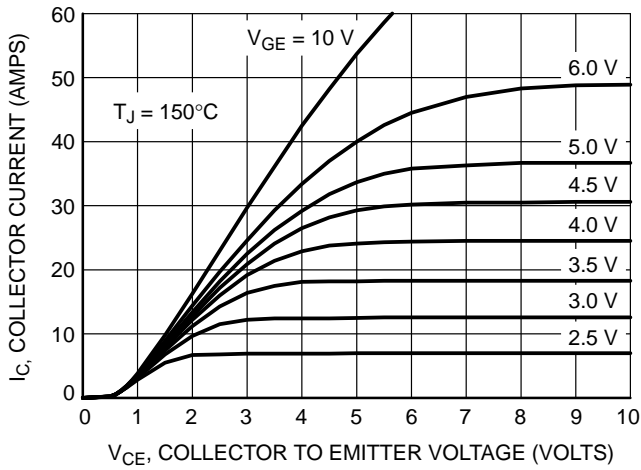


Figure 3. Output Characteristics

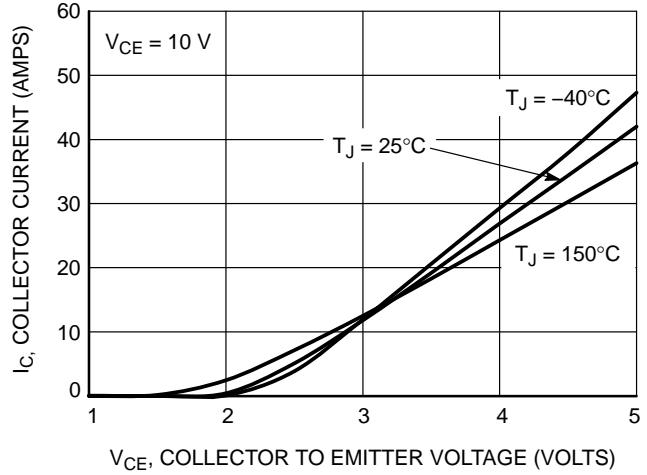


Figure 4. Transfer Characteristics

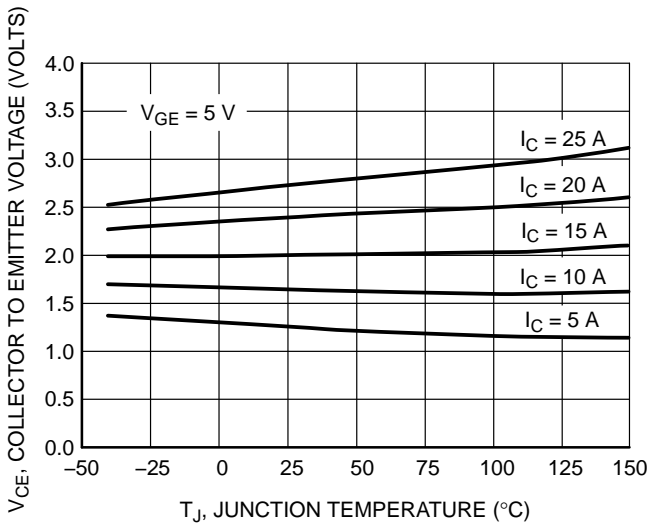


Figure 5. Collector-to-Emitter Saturation Voltage versus Junction Temperature

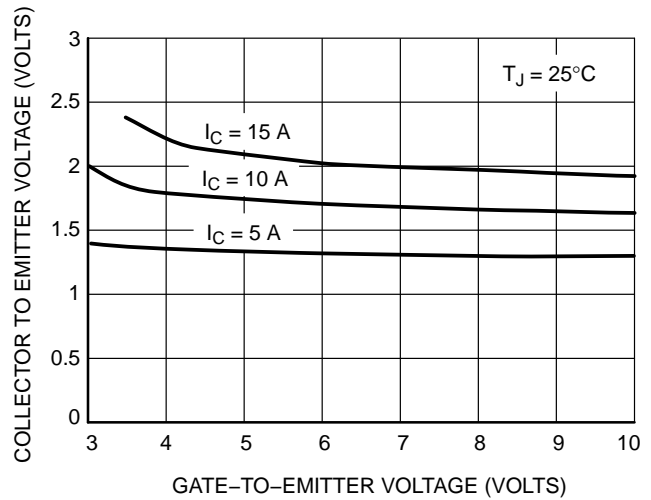
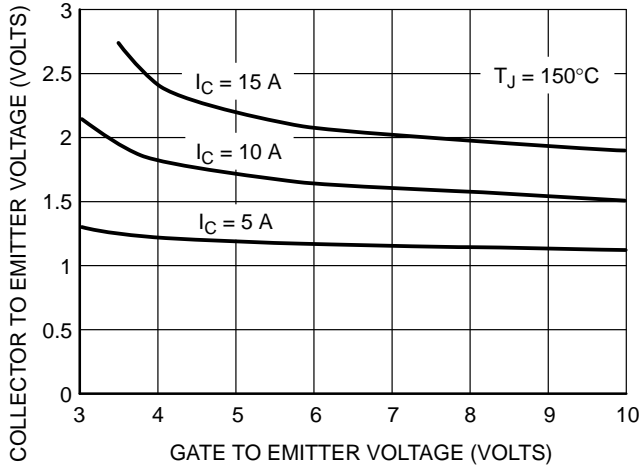


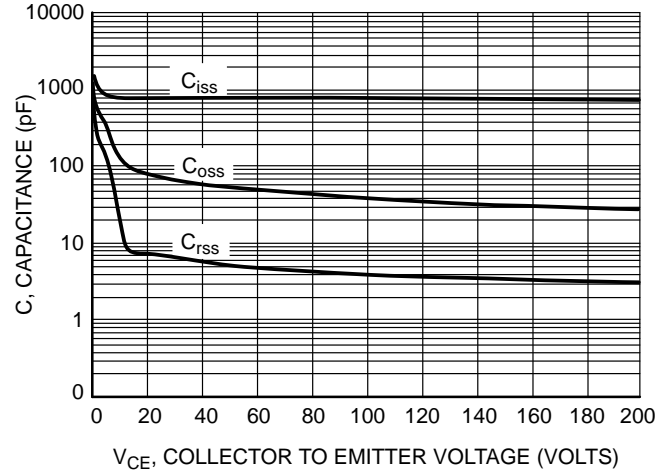
Figure 6. Collector-to-Emitter Voltage versus Gate-to-Emitter Voltage

# NGD18N40ACLB

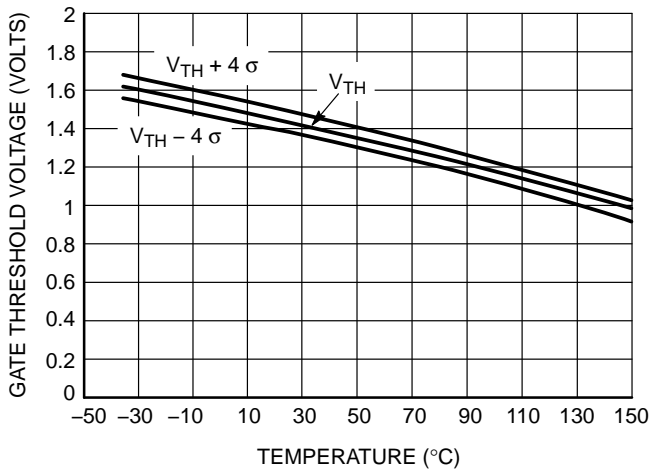
## TYPICAL ELECTRICAL CHARACTERISTICS (unless otherwise noted)



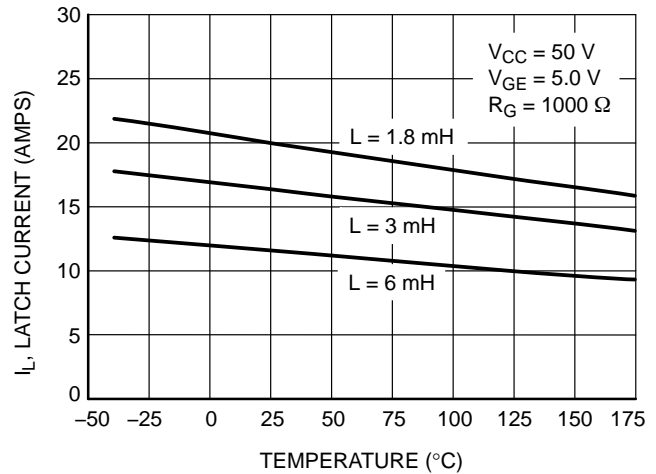
**Figure 7. Collector-to-Emitter Voltage versus Gate-to-Emitter Voltage**



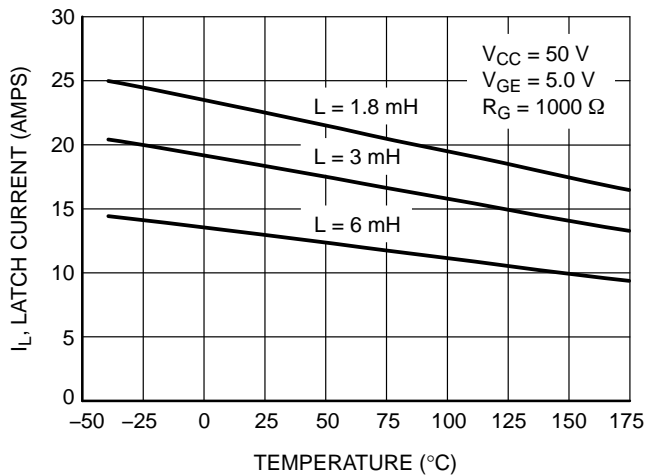
**Figure 8. Capacitance Variation**



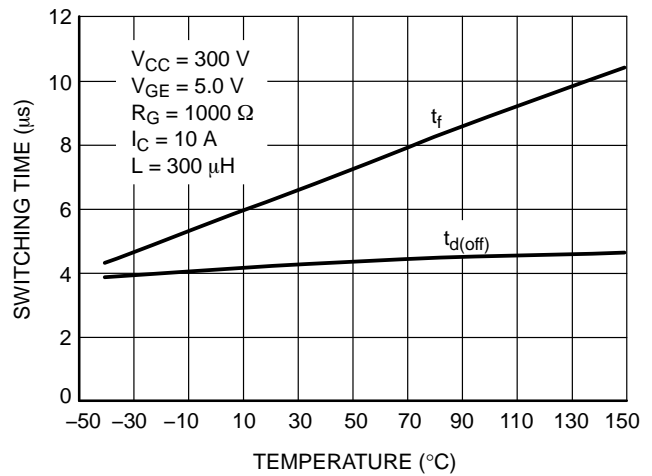
**Figure 9. Gate Threshold Voltage versus Temperature**



**Figure 10. Minimum Open Secondary Latch Current versus Temperature**

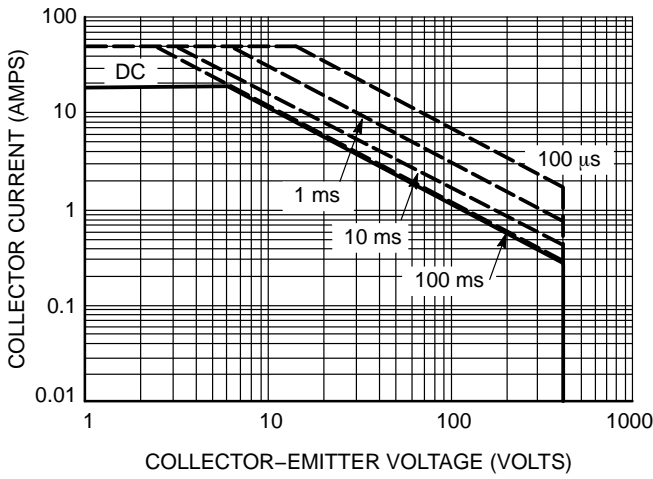


**Figure 11. Typical Open Secondary Latch Current versus Temperature**

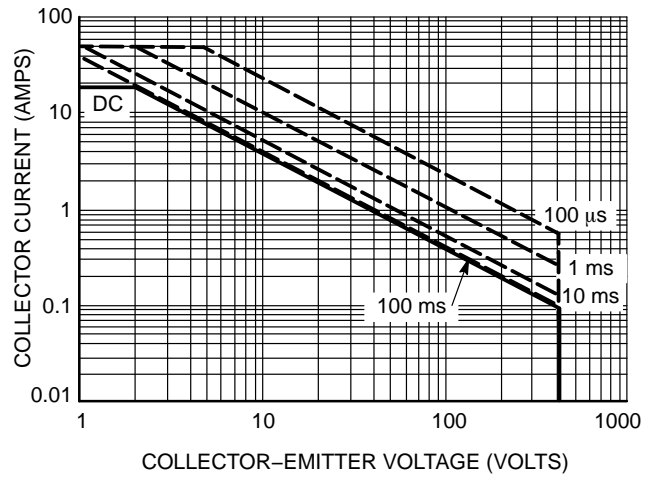


**Figure 12. Inductive Switching Fall Time versus Temperature**

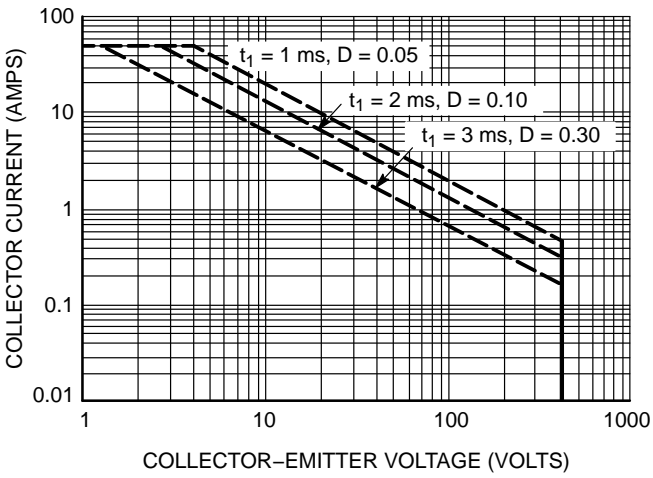
# NGD18N40ACLB



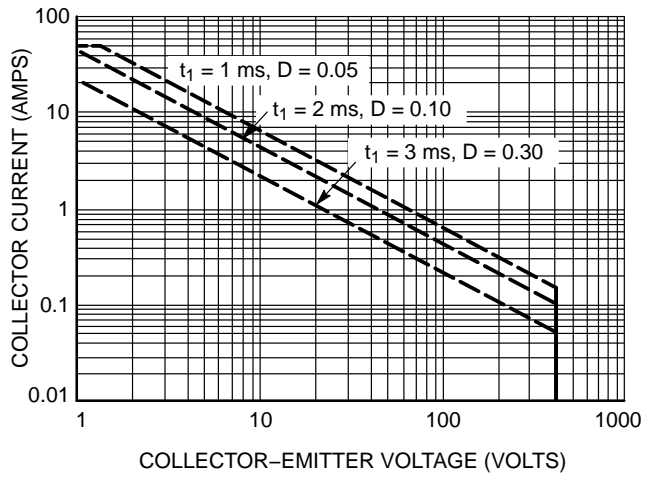
**Figure 13. Single Pulse Safe Operating Area (Mounted on an Infinite Heatsink at  $T_A = 25^\circ\text{C}$ )**



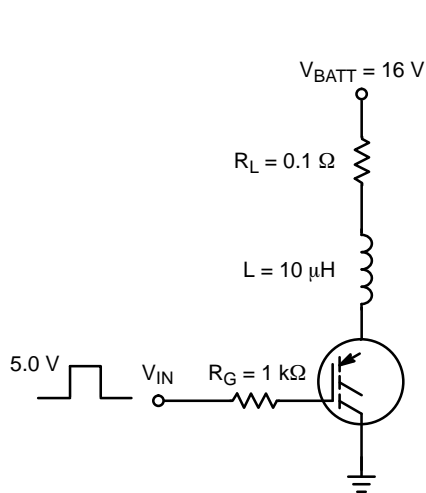
**Figure 14. Single Pulse Safe Operating Area (Mounted on an Infinite Heatsink at  $T_A = 125^\circ\text{C}$ )**



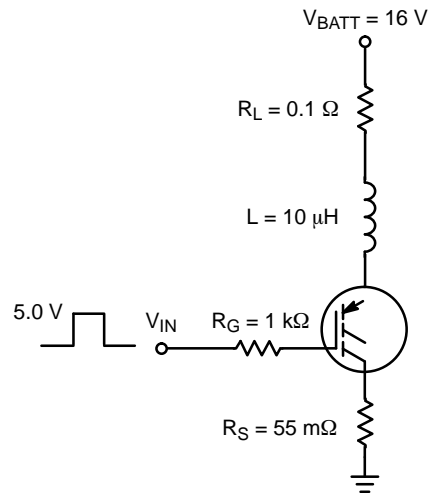
**Figure 15. Pulse Train Safe Operating Area (Mounted on an Infinite Heatsink at  $T_C = 25^\circ\text{C}$ )**



**Figure 16. Pulse Train Safe Operating Area (Mounted on an Infinite Heatsink at  $T_C = 125^\circ\text{C}$ )**



**Figure 17. Circuit Configuration for Short Circuit Test #1**



**Figure 18. Circuit Configuration for Short Circuit Test #2**

# NGD18N40ACLB

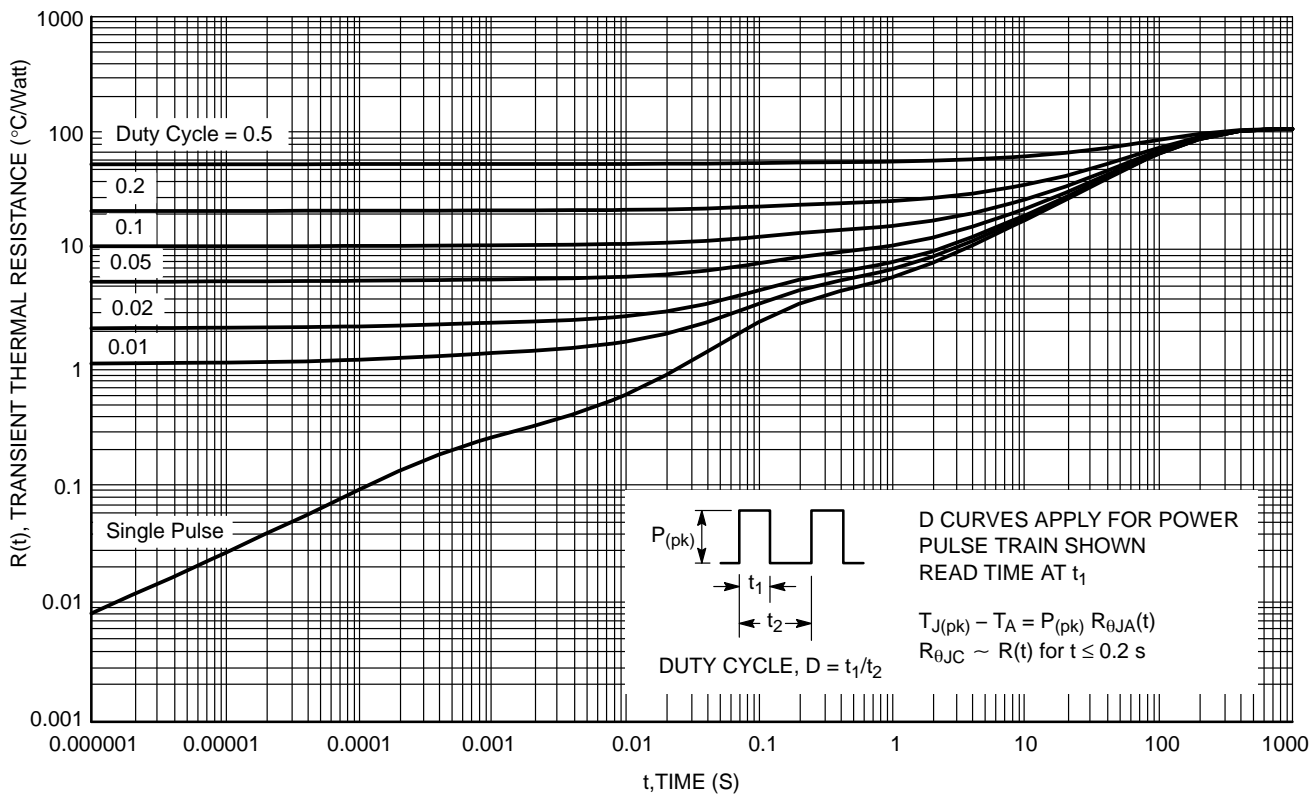
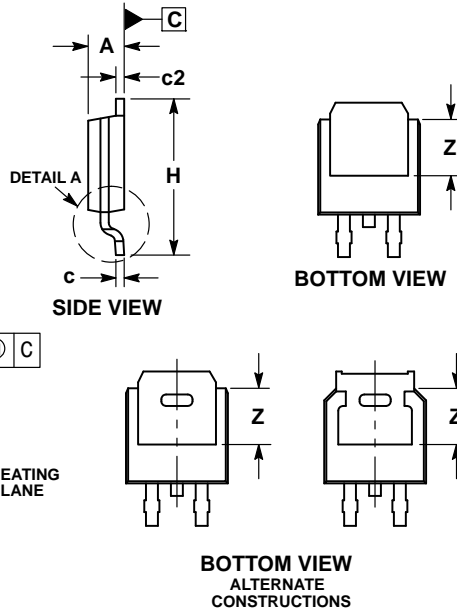
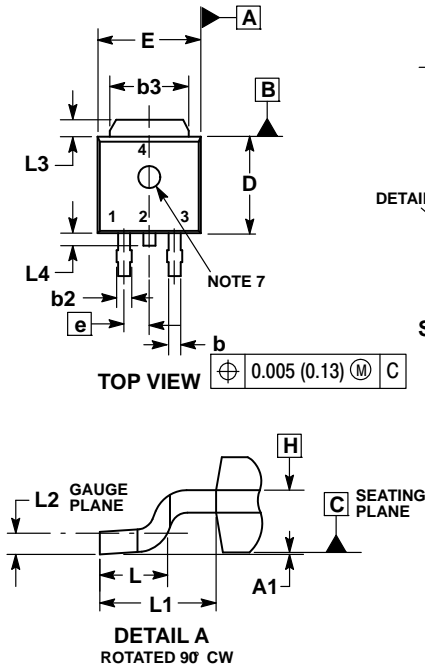


Figure 19. Transient Thermal Resistance (Non-normalized Junction-to-Ambient mounted on minimum pad area)

# NGD18N40ACLB

## PACKAGE DIMENSIONS

### DPAK (SINGLE GAUGE) CASE 369C ISSUE F



#### NOTES:

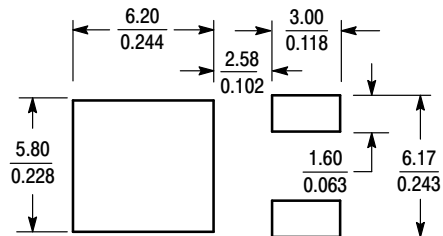
1. DIMENSIONING AND TOLERANCING PER ASME Y14.5M, 1994.
2. CONTROLLING DIMENSION: INCHES.
3. THERMAL PAD CONTOUR OPTIONAL WITHIN DIMENSIONS b3, L3 and Z.
4. DIMENSIONS D AND E DO NOT INCLUDE MOLD FLASH, PROTRUSIONS, OR BURRS. MOLD FLASH, PROTRUSIONS, OR GATE BURRS SHALL NOT EXCEED 0.006 INCHES PER SIDE.
5. DIMENSIONS D AND E ARE DETERMINED AT THE OUTERMOST EXTREMES OF THE PLASTIC BODY.
6. DATUMS A AND B ARE DETERMINED AT DATUM PLANE H.
7. OPTIONAL MOLD FEATURE.

DIM	INCHES		MILLIMETERS	
	MIN	MAX	MIN	MAX
A	0.086	0.094	2.18	2.38
A1	0.000	0.005	0.00	0.13
b	0.025	0.035	0.63	0.89
b2	0.028	0.045	0.72	1.14
b3	0.180	0.215	4.57	5.46
c	0.018	0.024	0.46	0.61
c2	0.018	0.024	0.46	0.61
D	0.235	0.245	5.97	6.22
E	0.250	0.265	6.35	6.73
e	0.090 BSC		2.29 BSC	
H	0.370	0.410	9.40	10.41
L	0.055	0.070	1.40	1.78
L1	0.114 REF		2.90 REF	
L2	0.020 BSC		0.51 BSC	
L3	0.035	0.050	0.89	1.27
L4	---	0.040	---	1.01
Z	0.155	---	3.93	---

#### STYLE 7:

- PIN 1. GATE
- COLLECTOR
- EMITTER
- COLLECTOR

### SOLDERING FOOTPRINT



SCALE 3:1  $\left(\frac{\text{mm}}{\text{inches}}\right)$

Information furnished is believed to be accurate and reliable. However, users should independently evaluate the suitability of and test each product selected for their own applications. Littelfuse products are not designed for, and shall not be used for, any purpose (including, without limitation, military, aerospace, medical, life-saving, life-sustaining or nuclear facility applications, devices intended for surgical implant into the body, or any other application in which the failure or lack of desired operation of the product may result in personal injury, death, or property damage) other than those expressly set forth in applicable Littelfuse product documentation. Warranties granted by Littelfuse shall be deemed void for products used for any purpose not expressly set forth in applicable Littelfuse documentation. Littelfuse shall not be liable for any claims or damages arising out of products used in applications not expressly intended by Littelfuse as set forth in applicable Littelfuse documentation. The sale and use of Littelfuse products is subject to Littelfuse Terms and Conditions of Sale, unless otherwise agreed by Littelfuse.

Littelfuse.com